

GEEMARC

CLEAR SOUND[®]

Now available to purchase from www.M2Cshop.com

HEAR THE DIFFERENCE

MyDECT 100

Amplified Big-Button Cordless Telephone



English



Now available to purchase from www.M2Cshop.com

Telecom SA

CONTENTS

Now available to purchase from www.M2Cshop.com

CONTENTS	1
INTRODUCTION	4
Unpacking the Telephone	5
DESCRIPTION	6
INSTALLATION	14
Location	14
Setting Up	15
Battery Use	16
HANDSET SETTINGS	17
On/Off Settings	17
Alarm Setting	18
Audio Setup	19
Ringer Setup	20
Tone Setup	22
Language Setting	23
HS Label	24
Auto Answer	25
Date & Time Setting	26
Select Base	28
Handset Default	29

Now available to purchase from www.M2Cshop.com

CONTENTS

Now available to purchase from www.M2Cshop.com

BASE SETTINGS	30
Terminate Handset	30
Dial Mode Setting	31
Flash Time Setting	32
Modify PIN	33
Base Default	34
USING THE TELEPHONE	35
Making a Call	35
Receiving a Call	36
Hands Free	37
Mute Function	37
Receiving Volume	38
Last Number Redial	38
Recalling Recent Numbers	38
Adding Recent Numbers to the Phone Book	39
Deleting Recent Numbers	40
Flash Signal	42
Paging the Handset	42
Call Timer	42
Key Lock	43
CALLER ID	44
View Caller ID Book	45
Dial a Number from the Caller ID Book	45
Add a Number from the Caller ID Book to the Phone Book	46
Delete a Number from the Caller ID Book	47
Delete all Numbers from the Caller ID Book	47

Now available to purchase from www.M2Cshop.com

CONTENTS

Now available to purchase from www.M2Cshop.com

PHONE BOOK	48
Create a Phone Book Entry	49
View Phone Book Entries	51
Dialling using a Phone Book Entry	51
Modify a Phone Book Entry	52
Delete a Phone Book Entry	54
Delete all Phone Book Entries	55
Phone Book Status	56
ADDITIONAL HANDSETS & BASES	57
Register a New Handset	58
Select a Base	59
Release a Handset	59
Internal Calls	60
Call Transfer between Handsets	61
Three Way Conference Call	62
CALL WAITING	63
Caller ID on Call Waiting	63
TROUBLESHOOTING	64
SAFETY INFORMATION	66
GUARANTEE	67
RECYCLING DIRECTIVES	69

Now available to purchase from www.M2Cshop.com

INTRODUCTION

Now available to purchase from www.M2Cshop.com. Congratulations on purchasing your Geemarc MyDECT100™ telephone. This telephone offers all the advantages of cordless technology (compliant with Digitally Enhanced Cordless Telecommunications-DECT standard) together with an easy to see big button keypad, ideal for those who suffer with poor sight. This telephone is also hearing aid compatible.

Its is important that you read the instructions below in order to use your Geemarc telephone to its full potential. Keep this user guide in a safe place for future reference.

This guide explains how to use the following telephone:

MyDECT100™

This guide applies to single and multiple handset systems.



Now available to purchase from www.M2Cshop.com

INTRODUCTION

Now available to purchase from www.M2Cshop.com

Unpacking the Telephone

When unpacking the telephone, you should find the following in the box:

- 1 MyDECT100™ handset
- 1 MyDECT100™ base
- 1 Mains power adaptor
- 1 Telephone line cord
- 2 x AAA Ni-MH rechargeable batteries
- 1 User Guide



For product support and help visit our website at

www.geemarc.com

Telephone 01707 384438

Or fax 01707 372529

Now available to purchase from www.M2Cshop.com

DESCRIPTION

Now available to purchase from www.M2Cshop.com

General Description

Handset Description (front)

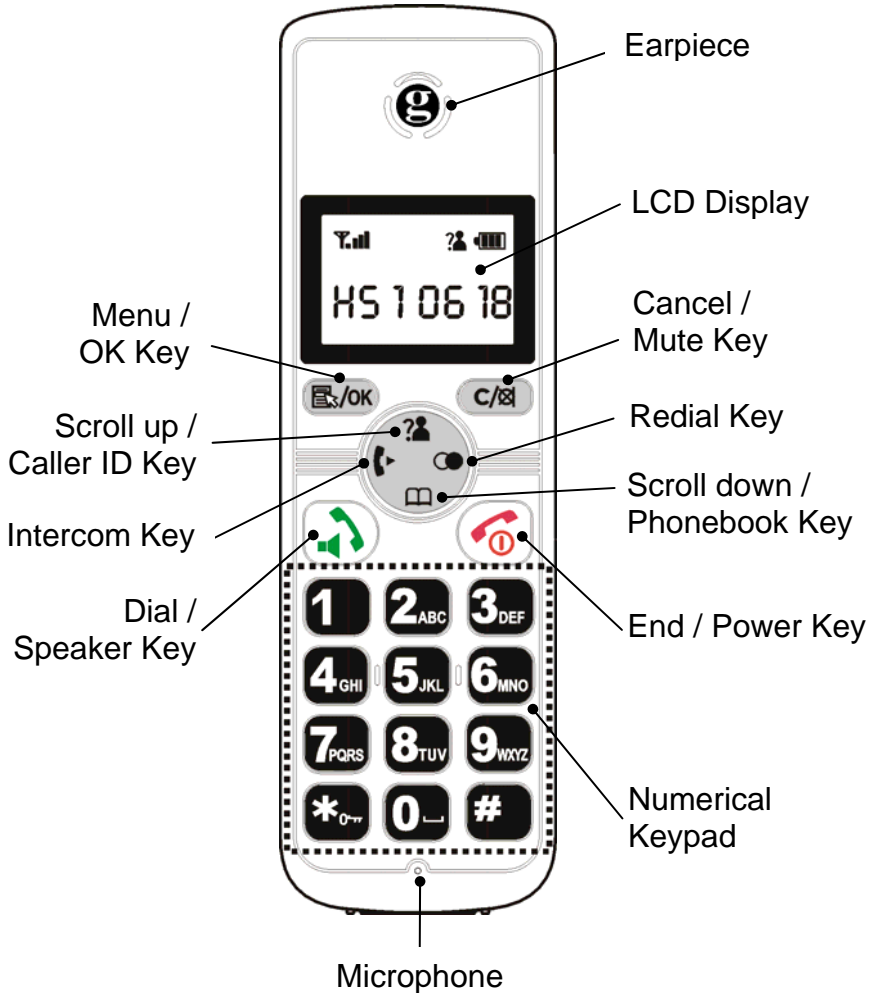

Now available to purchase from www.M2Cshop.com

DESCRIPTION

Now available to purchase from www.M2Cshop.com
Handset Description (Rear)

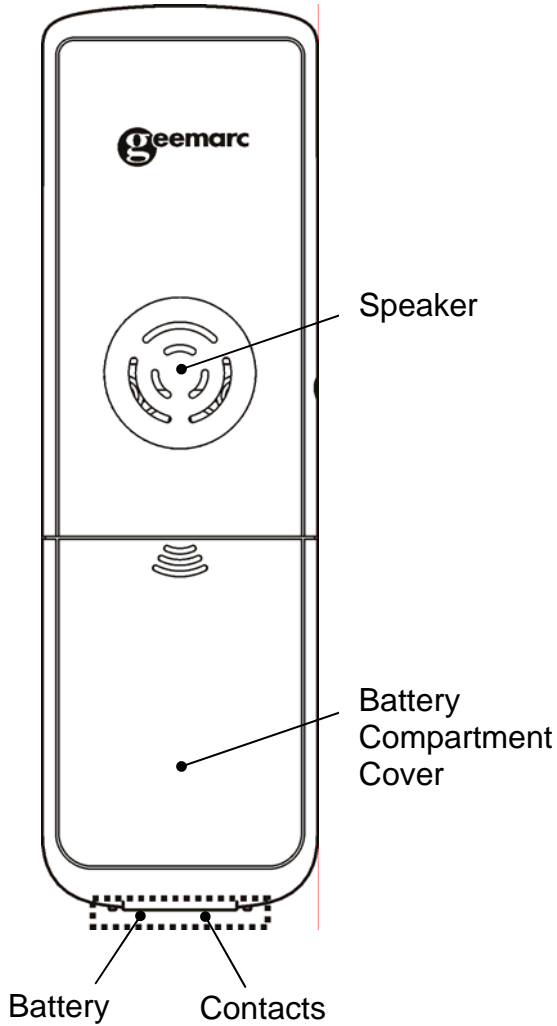

Now available to purchase from www.M2Cshop.com

DESCRIPTION

Now available to purchase from www.M2Cshop.com

Base Description (Top)

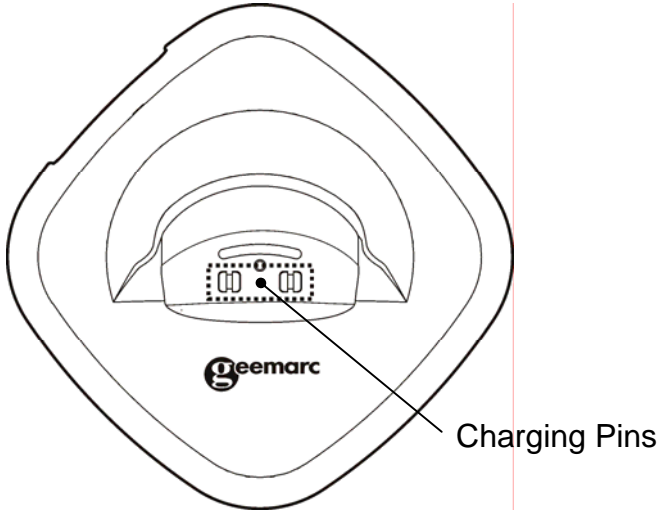



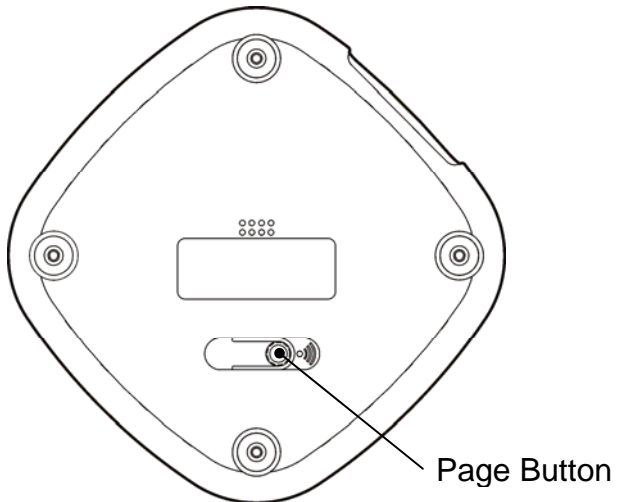



Base Description (Base)



Now available to purchase from www.M2Cshop.com

DESCRIPTION



Now available to purchase from www.M2Cshop.com

	<p>Dial/Speaker key</p> <p>Make/Answer a call Activates the speakerphone if pressed during a call</p>
	<p>End/Power key</p> <p>End a call. Long press to power the telephone on and off</p>
	<p>Navigation Button</p> <p> Up/CID key</p> <p>Scroll up through lists and menu options. Increase the earpiece/speakerphone volume during a call. Enter the Caller ID book</p> <p> Down/Phonebook key</p> <p>Scroll down through lists and menu options. Decrease the earpiece/speakerphone volume during a call. Enter the Phonebook</p> <p> INT key</p> <p>Set up an internal call to another handset. Transfer an incoming call to another handset. Set up a conference call with an external line and an internal handset.</p> <p> Redial key</p> <p>Enter the redial book Insert a pause when pre-dialing a number.</p>

Now available to purchase from www.M2Cshop.com

DESCRIPTION

Now available to purchase from www.M2Cshop.com

	<p>Menu key (left)</p> <p>Enter the menu functions in standby mode. Confirm selections & actions. Performs "Flash" function..</p>
	<p>Menu key (right)</p> <p>Return to the previous menu. Activate mute during a call. Delete an incorrect character/digit</p>
	<p>Star key</p> <p>Press and hold to turn on/off keypad lock function. Set up a conference call,</p>

Now available to purchase from www.M2Cshop.com

DESCRIPTION

Now available to purchase from www.M2Cshop.com

LCD Screen Description

The LCD screen is split into two distinct areas:

The icon area. This is found at the top of the screen. This displays the various system icons which help you to use the telephone.

The main area. This is found across the centre of the screen. It displays the following:

- number being dialled
- caller ID information
- phonebook
- menu information
- in standby mode, handset number and current time

Signal Strength icon

This is always displayed when your telephone is switched on. It shows the current signal strength. More bars indicate more signal strength. If the handset is too far from the base, this icon will blink on the LCD.



Line icon

This indicates that the line is engaged i.e. off hook



Hands-free icon

This indicates that hands-free is activated



New Call icon

This indicates that you have missed one or more calls



Key Lock icon

This indicates the keys are locked



Battery Status icon



This is always displayed when your telephone is switched on. It shows the level of battery charge. More bars indicate more battery charge





Now available to purchase from www.M2Cshop.com

DESCRIPTION

Now available to purchase from www.M2Cshop.com
LCD Screen Navigation



The  (**left side**) key is used to activate the menu. The  is used to deactivate the menu and return to standby mode from any menu.

The  and  keys are used to scroll through the menu.

 : move backward through the menu

 : move forward through the menu

The  (**left side**) key is also used to confirm an action or choice on a screen.

The  (**right side**) key is used to cancel an action/entry. If you press  (**right side**) from any menu (except whilst in number input mode), the telephone returns to the previous screen. If you press and hold  (**right side**) from any menu (except whilst in number input mode), the telephone returns to standby mode.

The telephone will automatically return to standby mode from any menu if no button is pressed for 30 seconds.

Now available to purchase from www.M2Cshop.com

DESCRIPTION

Now available to purchase from www.M2Cshop.com
Menu Map

Caller ID Book	
Phone Book	
	Add Entry
	Change Entry
	Delete Entry
	Delete All
	PB Status
BS Setting	
	Terminate HS
	Dial Mode
	Flash Time
	Modify PIN
	BS Default
HS Setting	
	Alarm
	Audio Setup
	Ring Setup
	Tone Setup
	Language
	HS Label
	Auto Answer
	Date & Time
	Select BS
	HS Default
Register	

Now available to purchase from www.M2Cshop.com

INSTALLATION

Now available to purchase from www.M2Cshop.com

Location

Ensure you situate the telephone close enough to the power socket so that the cable will reach safely without stretching. Also, the mains power needs to be easily accessible in case you need to disconnect the power.

Make sure the telephone is at least 1 metre away from other electrical products e.g.TV, radio and monitors so as to avoid interference. Also, avoid direct heat and sunlight.

We advise you to place the telephone on a table cloth or similar, as the rubber feet on the base can mark some surfaces

Handset Range

The telephone has a range of 30-50 metres indoors and up to 300 metres outdoors. The range will be reduced when there is no clear line of sight between the base and handset. Place the base as high as practically possible to ensure the best signal between the base and the handset. The  icon at the top left of the LCD display will blink and the signal strength bars will disappear to warn you if you have moved out of range of the base. You will need to move closer to the base station as the telephone line might be disconnected and the handset will return to standby.

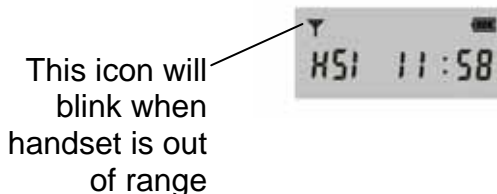

Now available to purchase from www.M2Cshop.com

INSTALLATION

Now available to purchase from www.M2Cshop.com

Setting Up

Plug the power cable into the power socket on the base. Plug the adaptor end of the power cable into the mains supply and switch the supply on. (*)

Connect the line cord plug to the line socket on the base. Connect the other end of the line cord to the PTT socket. (**)

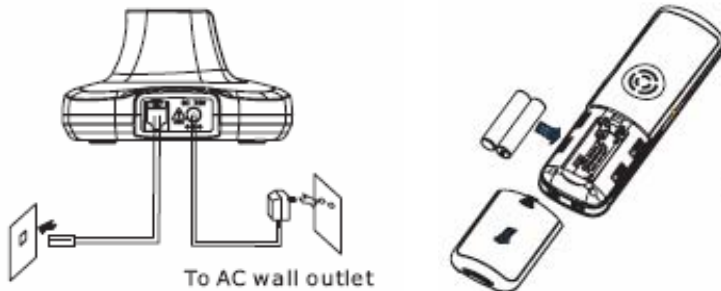

Install the rechargeable batteries in the handset. The handset requires two Nickel Metal Hydride (NiMH) AAA batteries. These are supplied with your telephone. Slide the battery cover in the direction of the arrow and pull it out. Check the battery polarity diagrams on the handset when inserting the batteries. Fit the battery cover by sliding the cover on to the back of the handset until it snaps shut.

Place the handset on the base, a short beep will be heard. The battery symbol  will be displayed on the handset. Once the handset is fully charged, the display will show a full battery symbol.

The telephone has an automatic charging control to avoid excessive charging.

Before the handset can be used, the handset batteries must be charged for a minimum of 15 hours on the MyDECT100TM base.

(*) Classified "hazardous voltage" according to EN60950 standard

(**) Classified TNY-3 according to EN60950 standard.

Now available to purchase from www.M2Cshop.com

INSTALLATION

Now available to purchase from www.M2Cshop.com

Battery Use

The  icon is continuously displayed at the top right corner of the LCD display. The icon indicates the level of battery power. The more bars displayed, the more power available.



When the battery is too weak for the telephone to operate, the handset will automatically switch off. Place the handset on the base to charge the handset battery. Under ideal conditions, the handset battery should give about 6 hours talktime or 150 hours standby on a single charge.

Now available to purchase from www.M2Cshop.com

HANDSET SETTINGS

Now available to purchase from www.M2Cshop.com

On/Off Settings

When the handset is placed on the charger it automatically switches on. Alternatively, press  for about 5 seconds. The telephone will enter subscription mode in which the handset is searching for a registered base.



On successfully finding a base, the LCD window will display the time (either set by yourself – see Handset Settings – Set Date & Time or it will be set automatically when you receive a call provided that you subscribe to a Caller ID service) and the handset number. The telephone is now in standby mode and is ready for use.



To turn the handset off, press  for about 5 seconds again. The LCD display will then switch off.

Note: When battery power is very low, the following is displayed. You must recharge immediately – replace the handset on the base.



Now available to purchase from www.M2Cshop.com



HANDSET SETTINGS

Now available to purchase from www.M2Cshop.com

Alarm Setting



You are able to set an alarm and adjust the settings using the handset.

Press  (**left side**) to activate the menu

Use  and  to scroll through the menu to select
'HS SETTING'



Press  (**left side**) to confirm



Press  (**left side**) to select
'ALARM'

Use  and  to scroll through the menu to select
'ON' OR 'OFF'

If you select 'ON' you will be prompted to enter the time in HH:MM format (24 hour format). Enter the alarm time using the numeric keypad.

Press  (**left side**) to confirm

Use  and  to scroll through the menu to select
'SNOOZE ON' or 'SNOOZE OFF'

Press  (**left side**) to confirm. Either press  to return to standby or wait 30 seconds

Notes:

Press any key to silence the alarm.

If you select 'SNOOZE ON', the alarm will ring at regular intervals of 10 minutes until you set snooze or alarm to off.

Now available to purchase from www.M2Cshop.com



HANDSET SETTINGS

Now available to purchase from www.M2Cshop.com



Audio Setup

The hands free speaker volume can be adjusted. Likewise, if using an earpiece, the volume heard through the earpiece can be adjusted.



Press  (**left side**) to activate the menu



Use  and  to scroll through the menu to select 'HS SETTING'



Press  (**left side**) to confirm

Use  and  to scroll through the menu to select 'AUDIO SETUP'

Press  (**left side**) to confirm

Use  and  to scroll through the menu to select 'SPEAKER VOL' or 'EARPIECE VOL'.

Use  and  to scroll through the menu to select required volume. There are 5 volume settings

Press  (**left side**) to confirm. Either press  to return to standby or wait 30 seconds

Now available to purchase from www.M2Cshop.com

HANDSET SETTINGS



Now available to purchase from www.M2Cshop.com

Ringer Setup



Ringer Tones

There is a choice of 10 handset ringer tones to notify you of incoming calls. You can select different tones to notify you if the call is internal (from other handsets registered to the same base) or external (from the telephone network).



Press  (**left side**) to activate the menu

Use  and  to scroll through the menu to select
'HS SETTING'



Press  (**left side**) to confirm



Use  and  to scroll through the menu to select
'RING SETUP'



Press  (**left side**) to confirm

Use  and  to scroll through the menu to select
'INT RING/EXT RING'

Press  (**left side**) to confirm

Use  and  to scroll through the menu to select
'MELODY'

Use  and  to scroll through the menu to select desired ringer tone/melody. As you scroll through, the telephone demonstrates the selected tone/melody

Press  (**left side**) to confirm. Either press  to return to standby or wait 30 seconds

Now available to purchase from www.M2Cshop.com



HANDSET SETTINGS

Now available to purchase from www.M2Cshop.com



Ringer Volume

There is a choice of five handset ringer volumes. The handset ringer can also be turned off.



Press  (**left side**) to activate the menu

Use  and  to scroll through the menu to select
'HS SETTING'



Press  (**left side**) to confirm



Use  and  to scroll through the menu to select
'RING SETUP'



Press  (**left side**) to confirm

Use  and  to scroll through the menu to select
'INT RING/EXT RING'

Press  (**left side**) to confirm

Use  and  to scroll through the menu to select
'VOLUME'

Use  and  to scroll through the menu to select
desired ringer volume. As you scroll through, the
telephone demonstrates the selected volume

Press  (**left side**) to confirm. Either press  to
return to standby or wait 30 seconds

Now available to purchase from www.M2Cshop.com

HANDSET SETTINGS



Now available to purchase from www.M2Cshop.com

Tone Setup



A key tone is heard every time you press a key on the handset. This can be switched to silent.

Note: Warning tones will still be emitted when an incorrect key is pressed.

Press  (**left side**) to activate the menu



Use  and  to scroll through the menu to select 'HS SETTING'



Press  (**left side**) to confirm

Use  and  to scroll through the menu to select 'TONE SETUP'

Press  (**left side**) to confirm

Press  (**left side**) again to select 'KEY TONE'

Use  and  to scroll through the menu to select 'ON' OR 'OFF'

Press  (**left side**) to confirm. Either press  to return to standby or wait 30 seconds

Now available to purchase from www.M2Cshop.com



HANDSET SETTINGS

Now available to purchase from www.M2Cshop.com

Language Settings

The handset supports nine languages. You can select the language used to display menu options.



Press  (**left side**) to activate the menu



Use  and  to scroll through the menu to select
'HS SETTING'

Press  (**left side**) to confirm

Use  and  to scroll through the menu to select
'LANGUAGE'

Press  (**left side**) to confirm

Use  and  to scroll through the menu to select the desired language. Each language will be displayed in its own native translation

Press  (**left side**) to confirm. Either press  to return to standby or wait 30 seconds

Now available to purchase from www.M2Cshop.com

HANDSET SETTINGS

Now available to purchase from www.M2Cshop.com



HS Label

The handset has a name - "HS n" (where n is either 1,2,3,4 or 5). This number indicates that the handset is the nth handset registered to the base i.e. HS 1 is the 1st handset registered to the base. The Handset name is displayed in standby mode. If desired, it can be changed.

Press  (left side) to activate the menu



Use  and  to scroll through the menu to select 'HS SETTING'

Press  (left side) to confirm

Use  and  to scroll through the menu to select 'HS LABEL'

Press  (left side) to confirm

Enter the new handset name (up to 6 characters) using the numeric keypad (see Phonebook – Add New Entry). Press  (left side) to delete the previous character if incorrect.

Press  (left side) to confirm. Either press  to return to standby or wait 30 seconds

Now available to purchase from www.M2Cshop.com



HANDSET SETTINGS

Now available to purchase from www.M2Cshop.com



Auto Answer

Auto answer allows you to answer a call by simply picking up the handset from the base without pressing any key.



Press  (**left side**) to activate the menu



Use  and  to scroll through the menu to select '**HS SETTING**'

Press  (**left side**) to confirm

Use  and  to scroll through the menu to select '**AUTO ANSWER**'

Press  (**left side**) to confirm

Use  and  to scroll through the menu to select '**ON**' or '**OFF**'.

Press  (**left side**) to confirm. Either press  to return to standby or wait 30 seconds

Now available to purchase from www.M2Cshop.com

HANDSET SETTINGS



Now available to purchase from www.M2Cshop.com

Date and Time Setting



Date Format

The date format displayed on the handset can be changed. The format can be either dd//mm or mm/dd.

Press  (**left side**) to activate the menu

Use  and  to scroll through the menu to select '**HS SETTING**'



Press  (**left side**) to confirm



Use  and  to scroll through the menu to select '**DATE & TIME**'

Press  (**left side**) to confirm

Press  (**left side**) again to select '**DATE FORM**'

Press  (**left side**) to confirm.

Use  and  to scroll through the menu to select '**DD-MM**' or '**MM-DD**'

Press  (**left side**) to confirm. Either press  to return to standby or wait 30 seconds



Now available to purchase from www.M2Cshop.com

HANDSET SETTINGS



Now available to purchase from www.M2Cshop.com

Date & Time Setting



Press  (left side) to activate the menu

Use  and  to scroll through the menu to select
'HS SETTING'

Press  (left side) to confirm



Use  and  to scroll through the menu to select
'DATE & TIME'

Press  (left side) to confirm

Use  and  to scroll through the menu to select
'SET DATE' or 'SET TIME'

Press  (left side) to confirm.

Enter the current date or time (24hr format) using the numeric keypad

Press  (left side) to confirm. Either press  to return to standby or wait 30 seconds

Notes: If you subscribe to a Caller ID service, the time will be set automatically when you receive a call.

Now available to purchase from www.M2Cshop.com



HANDSET SETTINGS

Now available to purchase from www.M2Cshop.com



Select Base

You can select a base from those already registered to the handset



Press  (**left side**) to activate the menu

Use  and  to scroll through the menu to select
'HS SETTING'

Press  (**left side**) to confirm

Use  and  to scroll through the menu to select
'SELECT BS'

Press  (**left side**) to confirm

Use  and  to scroll through the list of registered bases to select the base required

Press  (**left side**) to confirm

'SELECT BS n' will be displayed (n is the number of the registered base). Press  (**left side**) to confirm, a confirmation beep will be heard

Now available to purchase from www.M2Cshop.com



HANDSET SETTINGS

Now available to purchase from www.M2Cshop.com



Handset Default

You can reset the handset settings to the factory default.

Press  (**left side**) to activate the menu

Use  and  to scroll through the menu to select
'HS SETTING'

Press  (**left side**) to confirm

Use  and  to scroll through the menu to select
'HS DEFAULT'

Press  (**left side**) to confirm

You will be prompted to enter the PIN code (default is
0000).

Press  (**left side**) to confirm

If the PIN code is accepted, all handset settings will be
reset to the factory default. You will automatically be
returned to standby mode

Now available to purchase from www.M2Cshop.com



BASE SETTINGS

Now available to purchase from www.M2Cshop.com

Terminate Handset

You can delete a handset registration from a base.

Press  (**left side**) to activate the menu

Use  and  to scroll through the menu to select
'BS SETTING'



Press  (**left side**) to confirm

Press  (**left side**) again to select
'TERMINATE HS'

Press  (**left side**) to confirm

You will be prompted to enter the PIN code (default is
0000).

Press  (**left side**) to confirm

Use  and  to scroll through the list of registered
handsets to select the handset required

Press  (**left side**) to confirm (if the current handset or
a non-existent handset is selected, a warning beep will be
heard)

The selected handset will be deregistered

Now available to purchase from www.M2Cshop.com

BASE SETTINGS



Now available to purchase from www.M2Cshop.com

Dial Mode Setting



In the UK, all telephone exchanges now use Tone dialling. The dial mode setting is pre-set to Tone.

If your telephone does not dial out, it is probably being used from an older private switchboard (PBX). In this case, the dial mode must be changed to Pulse.



Press  (**left side**) to activate the menu



Use  and  to scroll through the menu to select
'BS SETTING'

Press  (**left side**) to confirm

Use  and  to scroll through the menu to select
'DIAL MODE'

Press  (**left side**) to confirm

Use  and  to scroll through the menu to select
'TONE' or **'PULSE'**.

Press  (**left side**) to confirm. Either press  to return to standby or wait 30 seconds

Now available to purchase from www.M2Cshop.com



BASE SETTINGS

Now available to purchase from www.M2Cshop.com



Flash Time Setting

The flash time setting can be changed.



Press  (**left side**) to activate the menu



Use  and  to scroll through the menu to select 'BS SETTING'

Press  (**left side**) to confirm

Use  and  to scroll through the menu to select 'FLASH TIME'

Press  (**left side**) to confirm

Use  and  to scroll through the menu to select 'SHORT' or 'LONG'.

Press  (**left side**) to confirm. Either press  to return to standby or wait 30 seconds

Now available to purchase from www.M2Cshop.com



BASE SETTINGS

Now available to purchase from www.M2Cshop.com



Modify PIN

The PIN is pre-set to '0000'. This can be changed – this is recommended for confidentiality.

Press  (left side) to activate the menu

Use  and  to scroll through the menu to select 'BS SETTING'

Press  (left side) to confirm



Use  and  to scroll through the menu to select 'MODIFY PIN'

Press  (left side) to confirm

You will be prompted to enter the old PIN code (default is 0000). If the old PIN code is accepted, you will be prompted to enter a new PIN code.

Enter new PIN code and press  (left side) to confirm.

You will be prompted to confirm the new PIN code.
Enter new PIN code again..

Press  (left side) to confirm. Either press  to return to standby or wait 30 seconds

Now available to purchase from www.M2Cshop.com



BASE SETTINGS

Now available to purchase from www.M2Cshop.com



Base Default

You can reset the base settings to the factory default.

Press  (**left side**) to activate the menu

Use  and  to scroll through the menu to select
'BS SETTING'

Press  (**left side**) to confirm

Use  and  to scroll through the menu to select
'BS DEFAULT'

Press  (**left side**) to confirm

You will be prompted to enter the PIN code (default is 0000).

Press  (**left side**) to confirm

If the PIN code is accepted, all base settings will be reset to the factory default. You will be automatically returned to standby mode



Now available to purchase from www.M2Cshop.com

USING THE TELEPHONE

Now available to purchase from www.M2Cshop.com

Making a Call

Pick up handset.

Press .  will be displayed on the LCD

When you hear dialing tone, dial the number on the keypad.

To end the call simply press  or place the handset on the base



Pre-Dialling

Pick up handset. Dial the number on the keypad
(up to 32 digits)

Press , the number is automatically dialled

To end the call simply press  again or place the handset on the base

Note: If you make an incorrect entry while pre-dialling the telephone number :

- Press  (**right side**) to clear the last digit and then enter the correct number
- Press  (**right side**) for more than one second to clear all digits entered and return to standby mode.

Now available to purchase from www.M2Cshop.com

USING THE TELEPHONE

Now available to purchase from www.M2Cshop.com

Receiving a Call

When an incoming call is received the telephone rings. If the caller can be identified (due to subscription to a Caller ID service), the caller's telephone number will be displayed. If this caller's number is stored on the Phonebook, the associated name will be displayed





Press  .to answer

Or

If auto answer is activated, simply lift the handset out of the base

To end the call simply press  or replace the handset on the base

Call duration is always displayed once you hang up.

Note: You can alter the ringer volume whilst the telephone is ringing. Simply use  and  to select the desired volume.

Now available to purchase from www.M2Cshop.com



USING THE TELEPHONE



Now available to purchase from www.M2Cshop.com

Hands Free

You can turn on the speakerphone built into the handset either before or during a call. In this mode there is no need to hold the handset. You will hear the third party through the speaker and the microphone will pick up your voice.

Before making a call, press  twice to turn hands free on. The  icon will be displayed on the LCD.

Press  during a call to turn hands free on. The  icon will be displayed on the LCD.

Press  again during a call to turn hands free off. The  icon will disappear from the LCD.

Note: To adjust the speakerphone volume use Audio Setup in Handset Settings.

Mute Function

If you wish, you can speak privately to someone else in the room with you without your caller overhearing. You will still be able to hear the caller but they cannot hear you during the mute operation.

During a call, press  (right side)

The LCD will show 'CALL MUTED' which indicates that your voice is muted to the call and the caller cannot hear you speaking

Press  (right side) again to resume the conversation.



'CALL MUTED' will disappear from the LCD display

Now available to purchase from www.M2Cshop.com

USING THE TELEPHONE

Now available to purchase from www.M2Cshop.com

Receiving Volume

During a conversation, the  and  keys adjust the ear piece volume level. The volume can be adjusted from level 1 to 5. The selected volume is displayed in the LCD display. The receiving volume range is 0dB to 12dB.

Last Number Redial

To redial the last number dialled:

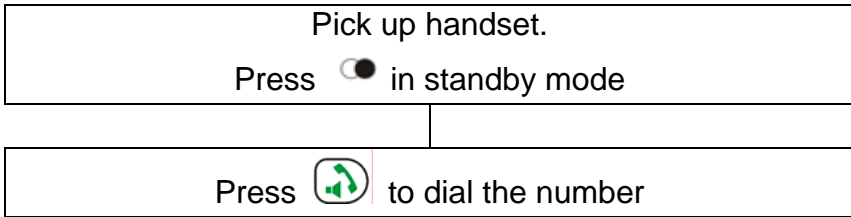

Recalling Recent Numbers

You can call back any of the last 10 numbers dialled as follows:

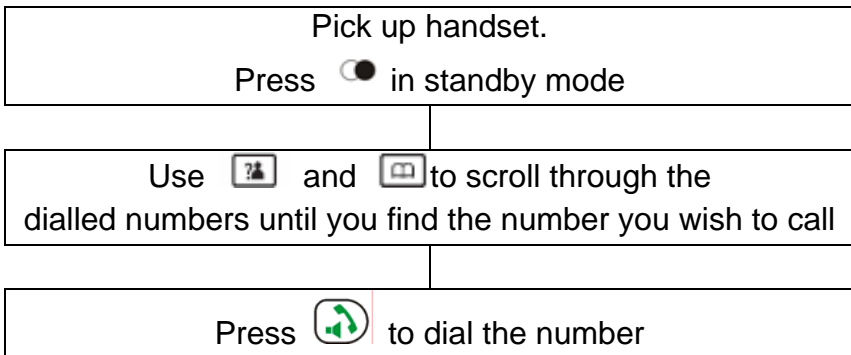

Notes:

- When no numbers are found, **EMPTY** is displayed
 - If the redial memory is full i.e. 10 numbers stored, each time you dial a new number, the oldest number stored is automatically erased and the redial memory is updated.
- Now available to purchase from www.M2Cshop.com



USING THE TELEPHONE

Now available to purchase from www.M2Cshop.com

Adding Recent Numbers to the Phone Book

Pick up handset.

Press  in standby mode

Use  and  to scroll through the dialled numbers until you find the number you wish to add to phone book

Press  (**left side**) to confirm



Press  (**left side**) again to select
'ADD TO PB'



The display will show 'NAME?' Enter the name you wish using the numeric keypad (see character map below)

Press  (**left side**) to confirm

The display will show the selected number from the recently dialled list

Press  (**left side**) to confirm

Use  and  to scroll through the melody menu to select desired ring tone. As you scroll through, the telephone demonstrates the selected melody. If you want to set a VIP number, you should select a special ring tone. The ring tone should be different from the external ring you have set. You can set up to 9 VIP ring tones associated with 9 numbers

Press  (**left side**) to confirm. Press  to return to standby or wait 30 seconds

Now available to purchase from www.M2Cshop.com

USING THE TELEPHONE



Now available to purchase from www.M2Cshop.com

Deleting Recent Numbers



To delete a specific number in the redial memory

Pick up handset.

Press  in standby mode

Use  and  to scroll through the dialled numbers until you find the number you wish to delete

Press  (left side) to select

Use  and  to scroll through the menu to select 'DELETE'

Press  (left side) to confirm

You will be prompted to confirm, press  (left side) again to confirm

Now available to purchase from www.M2Cshop.com



USING THE TELEPHONE

Now available to purchase from www.M2Cshop.com
To delete all numbers in the redial memory

Pick up handset.

Press  in standby mode

Press  (**left side**) to select

Use  and  to scroll through the menu to select
'DELETE ALL'

Press  (**left side**) to select

You will be prompted to confirm, press  (**left side**)
again to confirm

Now available to purchase from www.M2Cshop.com

USING THE TELEPHONE

Now available to purchase from www.M2Cshop.com

Flash Signal

The  (left side) key can also be used with special services such as Call Waiting (if provided by your service provider) or transferring external calls to another extension within a private switchboard. The LCD will display 'R'.

Paging the Handset

If you wish to locate the handset simply follow the instructions below:

Press , located on the bottom of the base for less than 5 seconds

All registered handsets will be paged and will ring for about 60 seconds

Press any button on the located handset or press  on the base again to stop paging mode

Call Timer



Your handset automatically times the duration of every external call. The time is shown during the call and for a few seconds after the call has ended.



Now available to purchase from www.M2Cshop.com



USING THE TELEPHONE

Now available to purchase from www.M2Cshop.com

Key Lock

When this feature is turned on, all buttons except for  will be locked and will not function. You can use  for answering incoming or intercom calls. When you complete the call and hang up, the telephone returns to lock mode. This lock feature is useful to avoid pressing buttons by mistake.

Switch lock On: Press  until the  icon and 'HS LOCKED' appear in the LCD display

Switch lock Off: Press  until the  icon disappears in the LCD display

Now available to purchase from www.M2Cshop.com

CALLER ID



Now available to purchase from www.M2Cshop.com
The features described in this section are only available if you subscribe to a Caller ID service from your network provider.

Caller ID means you can see who is calling on your handset display (provided the number is not withheld, unavailable or is an international call).

The display shows '**PRIVATE**' for a withheld number.

The display shows '**OUT OF AREA**' when someone calls from an area where the telephone company is not offering caller identification services or is not yet providing number delivery to your area.

Whether you take a call or not, the caller's details are stored in the Caller ID book. This book stores the last 40 incoming calls.

The  icon will be shown on the LCD if you missed one or more calls. If the Caller ID book is full, the  icon will blink.

CALLER ID



Now available to purchase from www.M2Cshop.com

View Caller ID Book

Press  (left side) to activate the menu

Press  (left side) to select
'CID BOOK'

The list of numbers in the Caller ID book will be displayed

Use  and  to scroll through the list



Alternatively, you can access the book by pressing  key whilst in standby mode.

Note: If there are no caller ID telephone numbers in the call book, '**EMPTY**' is displayed

Dial a Number from the Caller ID Book

Pick up handset.
Press  in standby mode

The list of numbers in the Caller ID book will be displayed

Use  and  to scroll through the list to find the required number

Press , the number is automatically dialled

Now available to purchase from www.M2Cshop.com

CALLER ID



Now available to purchase from www.M2Cshop.com

Add a Number from the Caller ID Book to the Phone Book

Pick up handset.

Press  in standby mode

The list of numbers in the Caller ID book will be displayed

Use  and  to scroll through the list until you find the required number



Press  (**left side**) again to select
'ADD TO PB'



The display will show 'NAME?' Enter the name you wish using the numeric keypad (see character map below)

Press  (**left side**) to confirm

The display will show the selected number from the CID book

Press  (**left side**) to confirm

Use  and  to scroll through the melody menu to select desired ringer tone. As you scroll through, the telephone demonstrates the selected melody. If you want to set a VIP number, you should select a special ring tone. The ring tone should be different from the external ring you have set. You can set up to 9 VIP ring tones associated with 9 numbers

Press  (**left side**) to confirm. Press  to return to standby or wait 30 seconds



Now available to purchase from www.M2Cshop.com

CALLER ID



Now available to purchase from www.M2Cshop.com

Delete a Number from the Caller ID Book

Pick up handset.
Press  in standby mode

Use  and  to scroll through the List until you find the number you wish to delete

Press  (left side) to select

Use  and  to scroll through the menu to select 'DELETE'

Press  (left side) to confirm

You will be prompted to confirm, press  (left side) again to confirm

Delete All Numbers from the Caller ID Book

Pick up handset.
Press  in standby mode

Press  (left side) to select

Use  and  to scroll through the menu to select 'DELETE ALL'

Press  (left side) to select

You will be prompted to confirm, press  (left side) again to confirm

Now available to purchase from www.M2Cshop.com

PHONE BOOK



Now available to purchase from www.M2Cshop.com
Telephone numbers can be stored in the phone book. It allows you to store frequently used numbers so that you can easily make a call without having to remember or enter the telephone number. The phone book can contain 50 entries. Each phone number can contain up to 20 digits and have a name of up to 12 characters.

PHONE BOOK

Now available to purchase from www.M2Cshop.com

Create a Phone Book Entry

Press  (left side) to activate the menu

Use  and  to scroll through the menu to select 'PHONE BOOK'



Press  (left side) to select



Press  (left side) again to select 'ADD ENTRY'

The display will show 'NAME?' Enter the name you wish using the numeric keypad (see character map below).
Up to 12 characters

Press  (left side) to confirm

The display will show 'NUMBER?' Enter the telephone number you wish using the numeric keypad (up to 20 digits)

Use  and  to scroll through the melody menu to select desired ringer tone. As you scroll through, the telephone demonstrates the selected melody. If you want to set a VIP number, you should select a special ring tone for it. The ring tone should be different from the external ring you have set. You can set up to 9 VIP ring tones associated with 9 numbers

Press  (left side) to confirm. You can then repeat the process again and add another entry to the phonebook or press  to return to standby or wait 30 seconds

Now available to purchase from www.M2Cshop.com

PHONE BOOK

Now available to purchase from www.M2Cshop.com

Note: Press  (right side) to clear the last digit and then enter the correct number

Press  (right side) for more than one second to clear all digits entered and return to standby mode.

Insert Pause

Inserting a pause provides a delay of 3 seconds. This is necessary with some telephone systems.

To insert a dialling pause between numbers when storing a number, press  until P appears in the LCD display.

Character Map

Key Characters
in order

0	(space)	0	&	/	.
1	-	1	@	_	
2	A	B	C	2	
3	D	E	F	3	
4	G	H	I	4	
5	J	K	L	5	
6	M	N	O	6	
7	P	Q	R	S	7
8	T	U	V	8	
9	W	X	Y	Z	9

Now available to purchase from www.M2Cshop.com

PHONE BOOK



Now available to purchase from www.M2Cshop.com

View Phone Book Entries

Pick up handset.

Press  in standby mode

The list of names in the phone book will be displayed

Use  and  to scroll through the list to find the required name



Press  (**left side**) to view the telephone number

Dialling using a Phone Book Entry

Pick up handset.

Press  in standby mode

The list of names in the phone book will be displayed

Use  and  to scroll through the list to find the required name

Press , the number is automatically dialled



Now available to purchase from www.M2Cshop.com

PHONE BOOK



Now available to purchase from www.M2Cshop.com

Modify a Phone Book Entry



Press  (**left side**) to activate the menu

Use  and  to scroll through the menu to select
'PHONE BOOK'

Press  (**left side**) to select

Use  and  to scroll through the menu to select
'CHANGE ENTRY'

Press  (**left side**) to select

Use  and  to scroll through the list to find the
required phone book entry to be modified

Press  (**left side**) to confirm

The cursor will start to flash on the right hand side of the
name. Modify name using  (**right side**) to clear the
previous digits and then enter the correct character(s)

Press  (**left side**) to confirm



The cursor will start to flash on the right hand side of the
number. Modify name using  (**right side**) to clear
the previous digits and then enter the correct character(s)



Press  (**left side**) to confirm

Now available to purchase from www.M2Cshop.com

PHONE BOOK

Now available to purchase from www.M2Cshop.com

Use  and  to scroll through the melody menu to select desired ringer tone. As you scroll through, the telephone demonstrates the selected melody. If you want to set a VIP number, you should select a special ring tone for it. The ring tone should be different from the external ring you have set. You can set up to 9 VIP ring tones associated with 9 numbers

Press  (**left side**) to confirm. You can then repeat the process again and modify another entry in the phonebook or press  to return to standby or wait 30 seconds



Now available to purchase from www.M2Cshop.com

PHONE BOOK



Now available to purchase from www.M2Cshop.com

Delete a Phone Book Entry



Press  (**left side**) to activate the menu

Use  and  to scroll through the menu to select
'PHONE BOOK'

Press  (**left side**) to select

Use  and  to scroll through the menu to select
'DELETE ENTRY'

Press  (**left side**) to select

Use  and  to scroll through the list to find the
required phone book entry to be modified

Press  (**left side**) to select

You will be prompted to confirm, press  (**left side**)
again to confirm



Now available to purchase from www.M2Cshop.com

PHONE BOOK



Now available to purchase from www.M2Cshop.com

Delete All Numbers from the Phone Book

Press  (**left side**) to activate the menu

Use  and  to scroll through the menu to select
'PHONE BOOK'

Press  (**left side**) to select

Use  and  to scroll through the menu to select
'DELETE ALL'

Press  (**left side**) to select

You will be prompted to confirm, press  (**left side**)
again to confirm

Now available to purchase from www.M2Cshop.com



PHONE BOOK

Now available to purchase from www.M2Cshop.com



Phone book Status

The phone book status shows the number of entries already stored in the phone book e.g. 05/50

Press  (**left side**) to activate the menu

Use  and  to scroll through the menu to select
'PHONE BOOK'

Press  (**left side**) to select

Use  and  to scroll through the menu to select
'PB STATUS'

Press  (**left side**) to select

The number of entries already stored in the phone book
will be displayed

Press  to return to standby or wait 30 seconds

Now available to purchase from www.M2Cshop.com

ADDITIONAL HANDSETS & BASES

Now available to purchase from www.M2Cshop.com
The handset that came with your base is already registered to the base (factory setting). This is registered as handset 1. Each additional handset you purchase must be registered to the base.

Up to 5 handsets can be registered to one base unit. This means you can make internal calls between registered handsets, transfer an incoming call between handsets and answer a call anywhere in the office/home at any time as all the handsets will call at the same time.

You can also register up to 4 base units to each handset. This will increase the phone range, allowing you to move between the telephone coverage areas.



ADDITIONAL HANDSETS & BASES

Now available to purchase from www.M2Cshop.com



Register a new Handset

Before registering a handset to the base, you should press and hold the  key on the bottom of the base for about 5 seconds and then release it.

Press  (**left side**) to activate the menu

Use  and  to scroll through the menu to select 'REGISTER'

Press  (**left side**) to select

Use  and  to scroll through the base names list

Press  (**left side**) to select desired base. The handset will search for the requested base and the relevant information will flash on the LCD.

If the base is found and the handset is successfully registered, you will be prompted to enter the PIN code (the default is 0000).

If the PIN code is accepted, the registration tone will sound and the base assigns a number to the handset. If the PIN code entered is invalid, a warning tone will sound, and the handset will return to the previous registration state.

Now available to purchase from www.M2Cshop.com

ADDITIONAL HANDSETS & BASES

Now available to purchase from www.M2Cshop.com

Select a Base

Your handset can be used with up to 4 bases. See Select Base in Handset Settings.

Note: In order to use the handset with more than one base unit, the handset must be registered with each base (see Register a New Handset section).

Release a Handset

A registered handset can be removed from a base if necessary. See Terminate Handset in Base Settings.

Now available to purchase from www.M2Cshop.com

ADDITIONAL HANDSETS & BASES

Now available to purchase from www.M2Cshop.com

Internal Calls

When using several handsets registered to the same base unit, you can make internal calls and transfer external calls between handsets.

Make an Internal Call

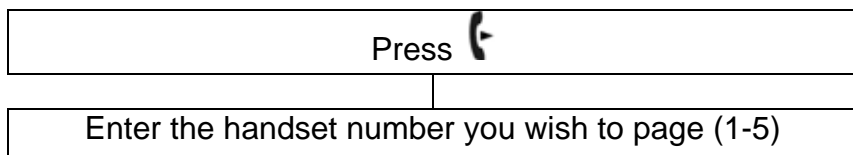



Notes:

If an incorrect handset number is entered i.e. one that does not exist, the handset will sound an error tone

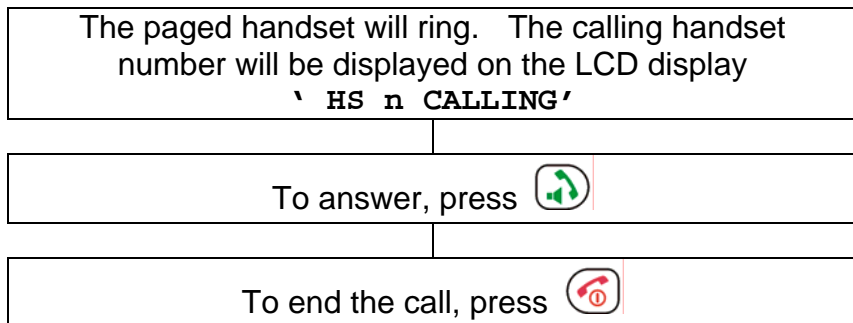
Receive an Internal Call



Notes:

If there is an external call during the course of an internal call, the caller's telephone number will be displayed. The internal call can be finished by pressing . The normal external call ring tone will be heard, press  to answer the call.

Now available to purchase from www.M2Cshop.com

ADDITIONAL HANDSETS & BASES

Now available to purchase from www.M2Cshop.com

Call Transfer between Handsets

An external call can be transferred from one handset to another.

During an external call, when you wish to transfer the call,
press . Your external caller will be placed on hold

Enter the handset number you wish to transfer to (1-5)

The paged handset will ring. The calling handset
number will be displayed on the LCD display
' HS n CALLING'

To answer the paged handset, press 

If required, you may now speak to the paged user.

To transfer the external call to the paged handset,
press 

OR

To cancel the call transfer and talk to the external caller
again, press 

Notes:

On transferring a call, you may hang up before the paged handset answers. The connection between the external caller and the paged handset is complete once you hang up.

If the paged handset does not answer a call within a predetermined time, the call will be transferred back to your handset.

Now available to purchase from www.M2Cshop.com

ADDITIONAL HANDSETS & BASES

Now available to purchase from www.M2Cshop.com

Three Way Conference Call

When you have both an external call and an intercom call in progress, you can set up a three way conference call

During an external call, press . Your external caller will be placed on hold

Enter the handset number you wish to join the three way conference call (1-5)

The paged handset will ring. The calling handset number will be displayed on the LCD display
' HS n CALLING'

To answer the paged handset, press 

The caller can now press  to start the three way call

Either of the two internal handsets can press  to leave the conference call at any time.

Now available to purchase from www.M2Cshop.com

CALL WAITING

Now available to purchase from www.M2Cshop.com

Caller ID on Call Waiting

When you subscribe to a Call Waiting service from your local telephone service provider, the LCD will display the name and number of the second caller while you are having a conversation with the first caller.

Press  (**left side**) to answer the second caller

When you have finished with the second caller press  (**left side**) again to resume your conversation with the first caller.

Note: If you have transferred an external call to another handset, the call waiting function will not work via the second handset.

Now available to purchase from www.M2Cshop.com

TROUBLESHOOTING

Now available to purchase from www.M2Cshop.com

General Checks

- Make sure that the telephone line cord and adaptor are correctly plugged in and they are not damaged.
- Make sure the batteries are inserted correctly.
- Make sure that the batteries are fully charged.
- Connect another telephone to the telephone PTT socket or move your telephone to another socket to track if the failure is coming from your telephone or your PTT socket.
- Make sure the power adaptor is properly connected

Handset not registering

- See general checks.

No display

- See general checks
- Check the handset is switched on

No connection between handset and base

- You may be out of range of the base. Move closer to the base

Handset on the base does not charge

- Make sure the handset is placed properly on the base. When charging, the battery symbol should be shown filling up.

Handset does not ring

- See general checks
- Ensure the ringer volume is not switched off

No tone when you press

- See general checks.
- Check for the handset number on the LCD display e.g. HS1. If this is not present you must register the handset (see Handset Registration section)

A warning tone is heard during a call:

- The batteries are empty. The handset needs to be replaced in the base in order to recharge.
- You are out of the base coverage area.

Now available to purchase from www.M2Cshop.com

TROUBLESHOOTING

Now available to purchase from www.M2Cshop.com

No number is displayed when the telephone rings:

- Please contact your telephone network provider to get the caller ID service.
- Even if you have subscribed to a caller ID service, if the caller does not want to show their number (private number), the display will show **'PRIVATE'**. **'OUT OF AREA'** might also be displayed if it is an international call
- It could be a call from a PBX. Caller ID may not work properly if the telephone is connected to a PBX.

Consistently short battery life

- Clean the charge contacts
- Replace the batteries

Nothing happens when you press any button

- Check the the keylock is switched off

Now available to purchase from www.M2Cshop.com

SAFETY INFORMATION

Now available to purchase from www.M2Cshop.com

General

Only use the power supply included with the product.

Only use the approved rechargeable batteries supplied.

Do not open the handset (except to replace the handset batteries) or base. Contact the helpline for all repairs.

Never dispose of batteries in a fire. There is a serious risk of explosion and/ or the release of toxic chemicals.

Do not place objects on the line cord or power cable that may cause damage.

If you are sure you are not going to use the telephone for over a month, remove the batteries.

Cleaning

Unplug the telephone. Clean the telephone with a soft cloth. Keep the base and handset charging contacts clean. Never use polishes or cleaning agents - they could damage the finish or the electrics inside.

Environmental

Do not expose to direct sunlight.

Always ensure there is a free flow of air over the surfaces of the telephone.

Do not place any part of your product in water and do not use it in damp or humid conditions e.g. bathrooms.

Do not expose your product to fire or other hazardous conditions.

Unplug your phone from the telephone socket during thunderstorms because it could damage your telephone. Your guarantee does not cover thunderstorm damage.

The telephone is designed for working within a temperature range of 5°C to 45°C.
Now available to purchase from www.M2Cshop.com

GUARANTEE

Now available to purchase from www.M2Cshop.com
From the moment your Geemarc product is purchased, Geemarc guarantee it for the period of one year. During this time, all repairs or replacements (at our discretion) are free of charge. Should you experience a problem then contact our help line or visit our website at www.geemarc.com. The guarantee does not cover accidents, negligence or breakages to any parts. The product must not be tampered with or taken apart by anyone who is not an authorized Geemarc representative. The Geemarc guarantee in no way limits your legal rights.

IMPORTANT: YOUR RECEIPT IS PART OF YOUR GUARANTEE AND MUST BE RETAINED AND PRODUCED IN THE EVENT OF AWARRANTY CLAIM.

**Please note: The guarantee applies to
the United Kingdom only**

DECLARATION: Geemarc Telecom SA hereby declares that this product is in compliance with the essential requirements and other relevant provisions of the Radio and Telecommunications Terminal Equipment Directive 1999/5/EEC and in particular article 3 section 1a, 1b and section 2. The telephone does not operate if the line current is lower than 18 mA.

The declaration of conformity may be consulted at www.geemarc.com



Now available to purchase from www.M2Cshop.com

GUARANTEE

Now available to purchase from www.M2Cshop.com

Electrical connection: The apparatus is designed to operate from a 230V 50Hz supply only. (Classified as 'hazardous voltage' according to EN60950 standard). The apparatus does not incorporate an integral power on/off switch. To disconnect the power, either switch off supply at the mains power socket or unplug the AC adaptor. When installing the apparatus, ensure that the mains power socket is readily accessible.

Telephone connection: Voltages present on the telecommunication network are classified TNV-3 (Telecommunication Network Voltage) according to the EN60950 standard.

Now available to purchase from www.M2Cshop.com

RECYCLING DIRECTIVES

Now available to purchase from www.M2Cshop.com
The WEEE (Waste Electrical and Electronic Equipment) has been put in place for the products at the end of their useful life are recycled in the best way.

When this product is finished with, please do not put it in your domestic waste bin.

Please use one of the following disposal options:

- Remove the batteries and deposit them in an appropriate WEEE skip. Deposit the product in an appropriate WEEE skip.
- Or, hand the old product to the retailer. If you purchase a new one, they should accept it.

Thus if you respect these instructions you ensure human health and environmental protection.



For product support and help visit our website at
www.geemarc.com

Telephone 01707 384438

Or fax 01707 372529

Now available to purchase from www.M2Cshop.com



Now available to purchase from www.M2Cshop.com



UGMyDECT100_En_Ver.1.0

geemarc UK

5 Swallow Court
Swallowfields
Welwyn Garden City
Hertfordshire, AL7 1SB
For product support:
01707 384433

www.geemarc.com

geemarc FRANCE

Parc de l'Etoile
2, rue Galilée
59760 Grande Synthe

TEL. SERVICE APRES VENTE :
03 20 58 70 00

www.geemarc.com

geemarc GERMANY

Walter-Kolb-Str.9-11
60594 Frankfurt-am-Main
Deutschland

T: 069 / 96 217 635
F: 069 / 96 217 620

www.geemarc.com

Now available to purchase from www.M2Cshop.com